





MOVIMENTO MOVIMIENTO MOVEMENT BEWEGUNG MOUVEMENT	ALIMENTAZIONE ALIMENTACION OPERATING VOLTAGE BETRIEBSSPANNUNG TENSION DE SERVICE	PRESTAZIONI FUNCIONAMIENTOS PERFORMANCES LEISTUNGEN EXÉCUTIONS	
---	---	---	---

SOLLEVAMENTO ELEVACION – HOISTING HEBEN – LEVAGE  INVERTER	400 V 50 Hz	▷ m/1' - kg	▷▷ m/1' - kg	▷▷▷ m/1' - kg	kW 9.2
		5 ↑	20 ↑ 21 ↓	40 ↑ 42 ↓	
		2500	2500	1000	

CARRELLO CARRILLO – JIB TROLLEY LAUFKATZE – DISTRIBUTION  INVERTER	400 V 50 Hz	▷ m/1' - kg	▷▷ m/1' - kg	kW 2.2
		15	40	

ROTAZIONE ROTACION – SLEWING DREHEN – ORIENTATION  INVERTER	400 V 50 Hz	▷ rpm	▷▷ rpm	kW 2.2
		0 → 0.2	0.2 → 0.85	



Conforme alle direttive
CEE sul livello acustico
2000/14/CE

Conforme con las directivas
CEE sobre el nivel acustico

In compliance with the EEC
instructions on noise level

Gemass EWG-Richtlinien fur
den Schall-Leistungspegel

Conforme aux directives CEE
sur le niveau acoustique

CURVE DI CARICO

CURVAS DE CARGAS – LOAD DIAGRAMS

LASTKURVEN – COURBES DE CHARGES

m	13.8	14.4	16	17	18	19	20	21	22	23	24	25	26	27	28	29	30
kg	2500	2391	2098	1956	1830	1718	1618	1528	1447	1373	1306	1244	1188	1135	1087	1042	1000
		2500	2211	2061	1929	1812	1707	1613	1527	1450	1379	1314	1255	1200			

BRACCIO IMPENNATO FLECHA IZADA LUFFING JIB AUSLEGER IN STEILSTELLUNG FLÈCHE RELEVÉE	 Carrellino distributore Carrellino distribuidor – Traversing trolley Verfahrbare laufkatze – Chariot distributeur	kg 700
--	---	--------

POTENZA RICHIESTA

POTENCIA-ELECTRICA NECESARIA – NECESSARY ELECTRIC POWER

KRAFTBEDARF – PUISSANCE ELECTRIQUE NECESSAIRE

 400 V - 50 Hz	SOLLEVAMENTO ELEVACION – HOISTING – HEBEN – LEVAGE	kg 2500
	14 kw	

GA 130D

TRASPORTO TRANSPORTE — TRANSPORT
TRANSPORT — TRANSPORT

ITK 3010 D

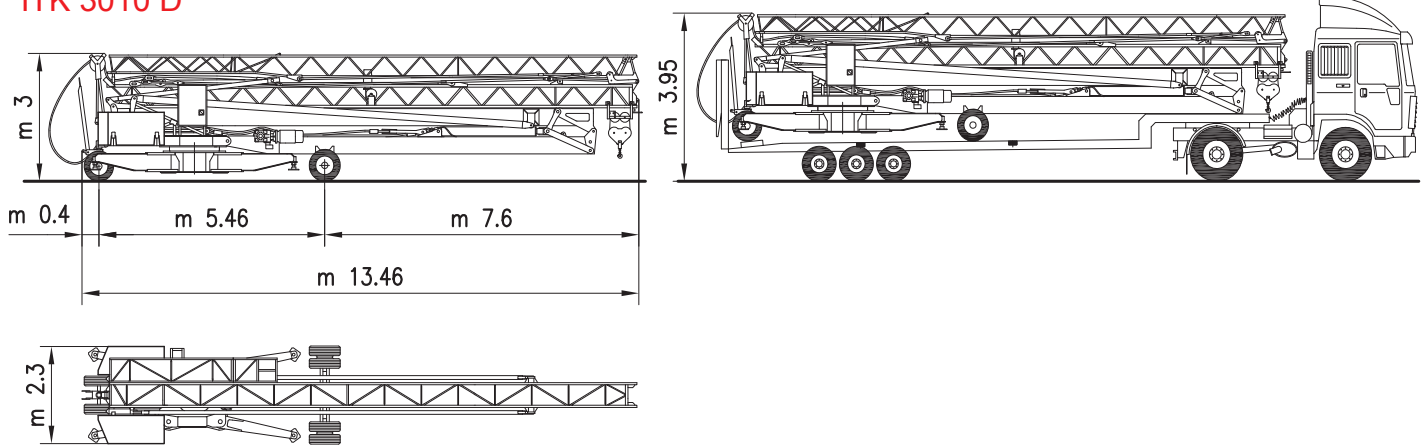

MONTAGGIO MONTAJE — ERECTION
MONTAGE — MONTAGE

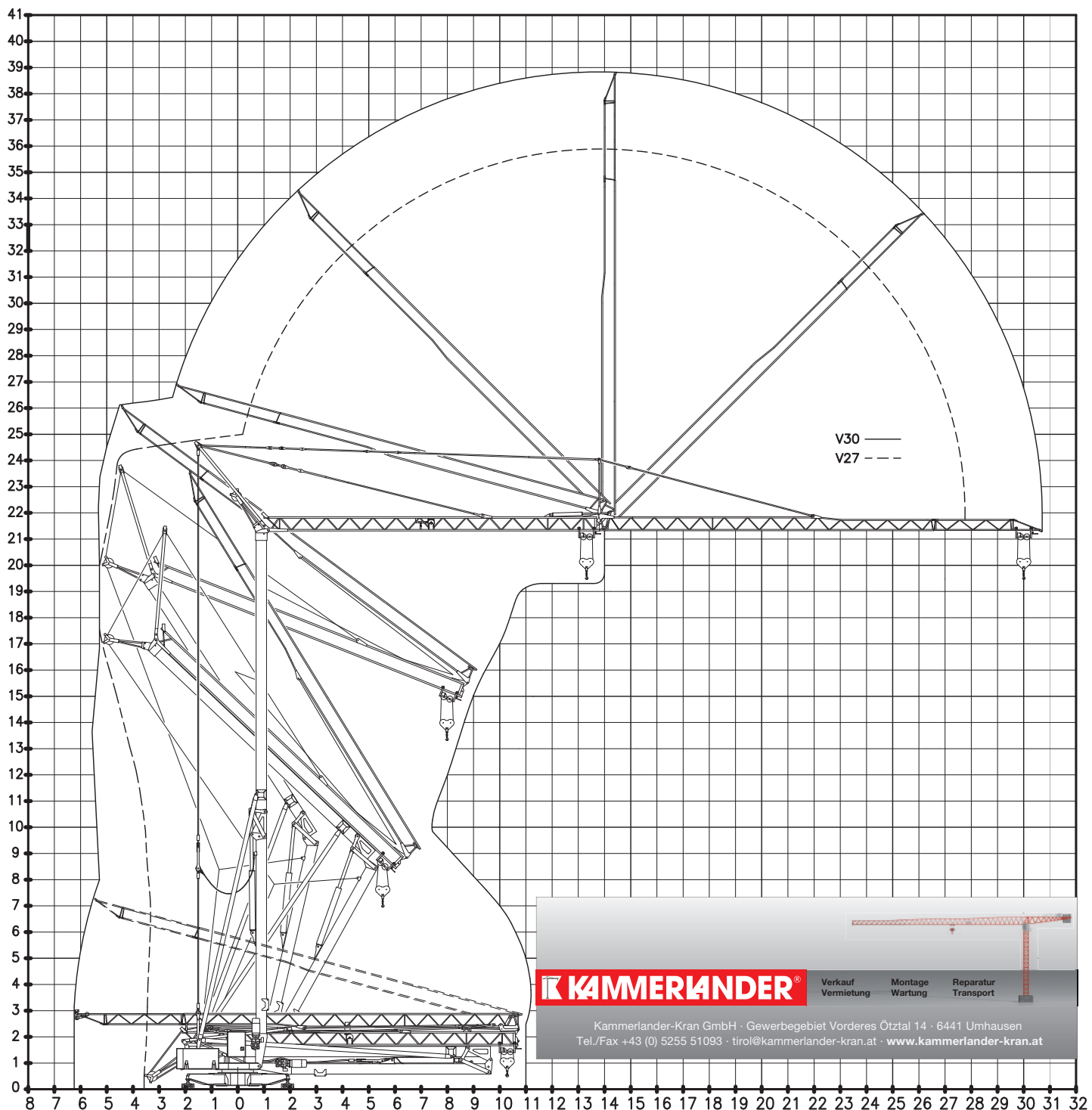

KAMMERLANDER®

Verkauf Vermietung Montage Wartung Reparatur Transport

Kammerlander-Kran GmbH · Gewerbegebiet Vorderes Ötztal 14 · 6441 Umhausen
Tel./Fax +43 (0) 5255 51093 · tirol@kammerlander-kran.at · www.kammerlander-kran.at